



SOSEN LED Driver, Your Smart Choice

Specifications

SS-160NM-A Series LED Driver

Model: SS-160NM-A260*

Description: 160W LED Driver

Rev.: V06

Release Date: 2023-09-11

SS-160NM-A Series LED Driver

SOSEN
LED DRIVER



LED DRIVER

NM-A Series



Features:

- ❑ Efficiency up to 94%
- ❑ Dimming: 0-10V,PWM,Resistor
- ❑ Isolated Dim-to-off
- ❑ AUX Power : 12V/0.2A
- ❑ Standby power<0.5W
- ❑ Protections: SCP/OTP/OVP
- ❑ Surge protection: CM: 6kV, DM: 6kV
- ❑ Warranty: 5 years



FC Class P

Description:

SS-160NM-A series are 160W non-isolated constant current LED Driver with 108-380Vac. It has DIM to Off, high efficiency, isolated auxiliary power supply, compact housing ,fully potted , high reliability, high cost performance and other advantages.

Applications:

Wall washers, Linear high bay, Flood lighting, Wall lamp

Model List:

Model	AC Input Range	Max. Pout	Vout Range	Full Power Vo Range	Iout	THD(Typ.)	PF(Typ.)	Eff.(Typ.)	Max.Tc
SS-160NM-A260*	108-380Vac	160W	180-260V	200V-260V	0.56-0.8A	10%	0.97	94%	90°C

Note:

- 1.Default Tested: at 277Vac, full load, Ta 25°C.
- 2.The performance of the LED Driver can be guaranteed within the full power Vo range.The voltage lower than full power Vo range, it is need to test the performance with the LED module;

SS-160NM-A Series LED Driver

“*” Means Additional Function

“*”	AUX 12V (suffix:H)	Dimming off 0-10V/PWM/Resistor	Adjust power (Single DIP)	Optical control	Remark
No Suffix					
B		✓			
BB		✓	✓		
BP		✓		✓	
BBP		✓	✓	✓	

“*” Means Additional Function

“*”	AUX 12V (suffix:H)	Dimming off 0-10V/PWM/Resistor	Adjust power (Single DIP)	Optical control	Remark
No Suffix					
BH	✓	✓			
BHB	✓	✓	✓		
BHP	✓	✓		✓	
BHBP	✓	✓	✓	✓	

SS-160NM-A Series LED Driver

Input Characteristics:

Parameter	Min.	Typ.	Max.	Remark
Rated AC Input Range	120Vac		347Vac	Ref. derating curve
AC Input Range	108Vac		380Vac	Ref. derating curve
Input Frequency Range	47Hz	50/60Hz	63Hz	
Max Input Current			1.6A	120Vac, Full load
Max Input Power			192W	120Vac, Full load
Max Inrush Current(120Vac)			80A	Cold start
Max Inrush Current(220Vac)			100A	Cold start
Max Inrush Current(347Vac)			120A	Cold start
Standby Power			0.5W	220Vac/50Hz, Dim-to-off, For BH model
Power Factor	0.95	0.97		220Vac/50Hz, Full load
	0.90			120-347Vac/50Hz, 60%-100% load
THD		10%	13%	277Vac, Full load
			20%	120-347Vac/50Hz, 60%-100% load

SS-160NM-A Series LED Driver

Output Characteristics:

Parameter	Min.	Typ.	Max.	Remark
O/P Voltage Range	180V		260V	Power derated @180-200V
Rated O/P Voltage	200V		260V	$P_o=V_o \cdot I_o=160W$, Full load
Rated O/P Current	0.62A		0.8A	0.8A for 200V,0.62A for 260V
Adj. O/P Current (AOC)Range	0.56A		0.8A	
No Load Voltage			/	Can not be used without load
Efficiency @120Vac	90.0%	92.0%		Output 260V/0.62A
Efficiency @220Vac	93.0%	94.0%		Output 260V/0.62A
Efficiency @347Vac	93.0%	95.0%		Output 260V/0.62A
O/P Current Tolerance	-5%		+5%	
O/P Current Ripple(PK-AV)		5%	10%	Full load
Start-up Current Overshoot			10%	Full load
Start-up Time			0.75S	120Vac,Full load
			0.5S	220Vac,Full load
Line Regulation	-5%		+5%	Full load
Load Regulation	-5%		+5%	
Temperature Coefficient	-0.06%/°C		+0.06%/°C	Tc:0°C~90°C
OTP	90°C	95°C	100°C	>Tc Typ., Current derating <Tc Min., Current recovery
Short Circuit Protection				Driver will not be damaged

SS-160NM-A Series LED Driver

Other Characteristics:

Parameter		Min.	Typ.	Max.	Remark
Aux Power	O/P Voltage	10.8V	12V	13.8V	For BH model
	O/P Current			200mA	
0-10V Dimming	Dim Vmax	0V		12V	DIM+ source current 100uA.
	Dim Range	10%Iomax		100%Ioset	Dimming prohibits reverse connection
	Rec.Dim Range	0V		10V	
PWM Dimming	PWM High	9.8V		10.2V	DIM+ source current 100uA.
	PWM Low	0V		0.3V	Dimming prohibits reverse connection
	Frequency	1KHz		2KHz	
	PWM Duty	0%		100%	
Resistor Dimming	Resistance	0Kohm		100Kohm	DIM+ source current 100uA.
	Dim Range	10%Iomax		100%Ioset	
Dim to Off	Dim off	0.7V	0.8V	0.95V	B Type: Afterglow
	Dim on	0.95V	1.1V	1.2V	BH Type: Without afterglow
Lifetime(Tc≤85°C)		≥50,000 hours			
MTBF		200,150 hours			220Vac, Full load, Ta=25°C (MIL-HDBK-217F)
Tc		90°C			
Warranty		5 years			Tc: 85°C
Net Weight(B Model)		485g			
Net Weight(BH Model)		535g			
Dimension(B Model)		185mm*52.5mm*34mm			L x W x H
Dimension(BH Model)		192mm*52.5mm*34mm			L x W x H

NOTE: All the parameters above are tested Ta 25°C and LED load, unless specified.

SS-160NM-A Series LED Driver

Environmental Requirements

Parameter	Min.	Typ.	Max.	Remark
Operating Temperature(Tcase)	-40°C	25°C	+90°C	
Storage Temperature	-40°C	25°C	+90°C	
Operation Humidity	10%RH		90%RH	
Storage Humidity	5%RH		95%RH	
Altitude	-65m		4000m	

Safety and EMI/EMS Standards

Certification	Standard	Status	Remark
UL/cUL	UL8750	✓	
TUV	EN 61347-2-13:2014/A1:2017 EN 61347-1:2015 EN 62493:2015		
RCM	AS/NZS61347.2.13		
CCC	GB 19510.14-2009		
CE	EN 61347-2-13:2014 EN61347-1:2008+A1:2011+A2:2013		

EMI/EMS	Criterion	Remark
Conduction Emission	FCC Part15: Subpart A ANSI 63.4:2014	Class A
Radiation Emission	FCC Part15: Subpart A ANSI 63.4:2014	Class A
Harmonic Current Emissions	IEC/EN 61000-3-2:2019+A1:2021	Class C
Surge	IEC/EN61000-4-5	DM: 6kV,CM: 6kV,Criterion B
Ring Wave	IEC/EN 61000-4-12	DM: 6kV,CM: 6kV,Criterion B

SS-160NM-A Series LED Driver

Safety Test Items:

Safety test items	Technical Indicators		Remark
Insulation Requirements	UL Insulation Requirements	TUV Insulation Requirements	
Input-Case	1600Vac	/	Basic insulation
Input-Dim	1600Vac	/	Reinforced insulation
O/P-Dim	1600Vac	/	Reinforced insulation
Dim-Case	500Vac	/	Basic insulation
Insulation Resistance	$\geq 10M\Omega$		Input-Dim,Test voltage:500Vdc
Ground Resistance	$\leq 0.1\Omega$		25A/1min
Leakage Current	$\leq 0.75mA$		347Vac

NOTE:

1. SOSEN warrants the LED Driver itself complies with EMC standard. However, LED Driver's EMC should be re-checked when integrated into lighting systems due to unexpected interference of components.
2. Please short (ACL and ACN), (V+ and V-), (Dim+ and Dim - and Vaux+ and Vaux-) when Hi-pot test.

Performance Curves:

Input Inrush Current

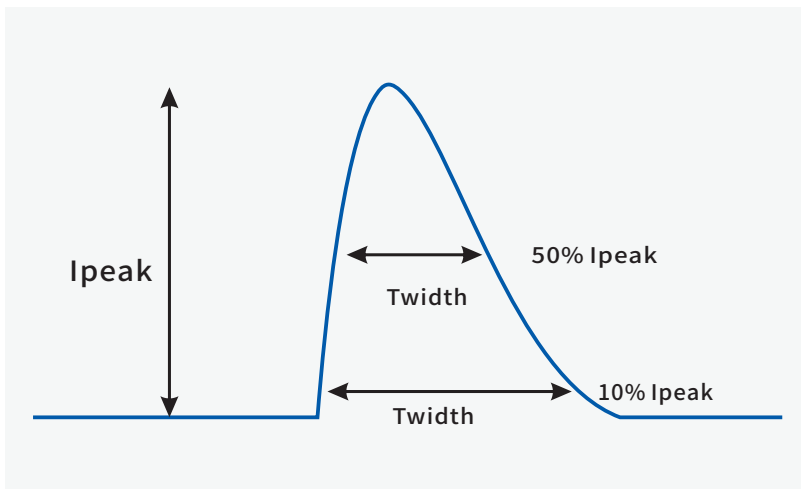

V _{in}	I _{peak}	T(@10% of I _{peak})	T(@50% of I _{peak})
120Vac	80A	400uS	
220Vac	100A		200uS
277Vac	120A	380uS	

SS-160NM-A Series LED Driver

Performance Curves:

Output Voltage Vs. Output Current(Dim/AOC Window)

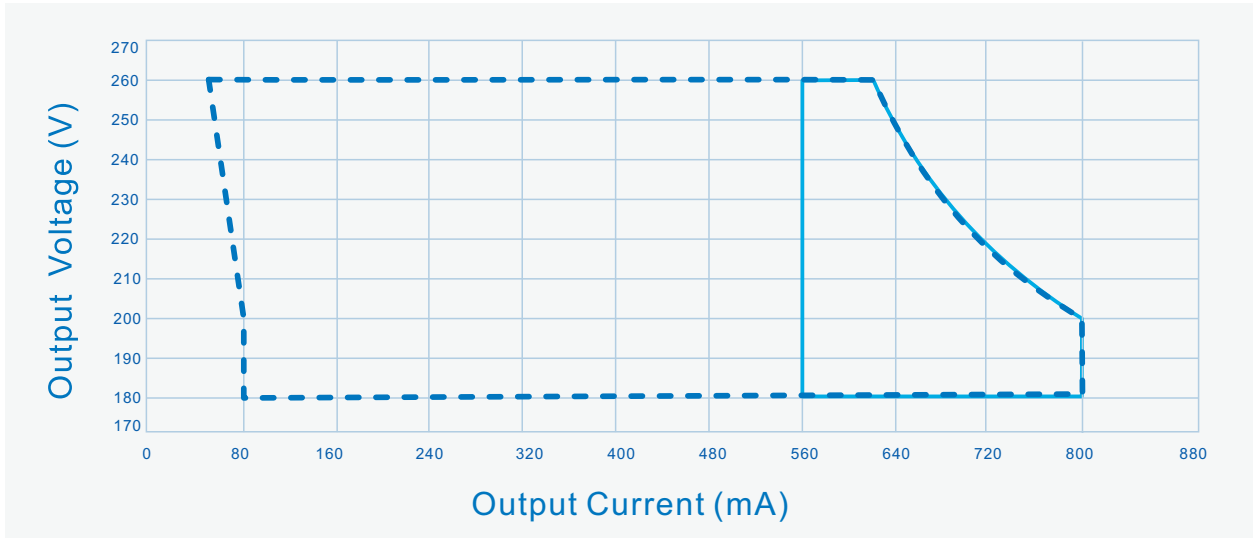

----- Dimming Window ————— AOC Window

Efficiency Vs. Output Voltage (Vin=120Vac)

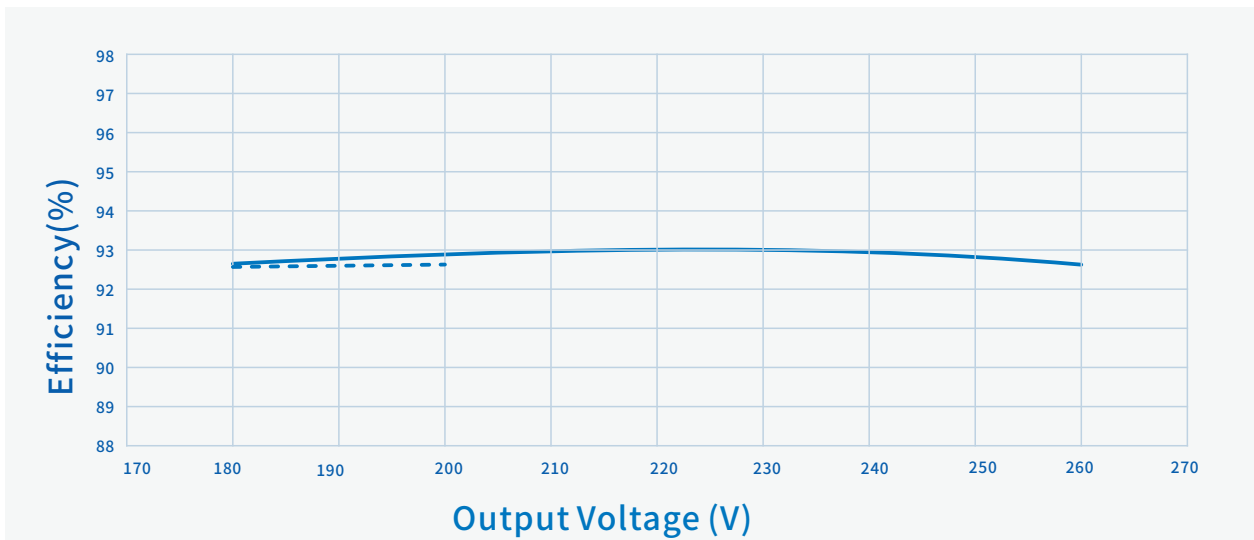

----- Io=800mA ————— Io=620mA

SS-160NM-A Series LED Driver

Performance Curves:

Efficiency Vs. Output Voltage ($V_{in}=220V_{ac}$)

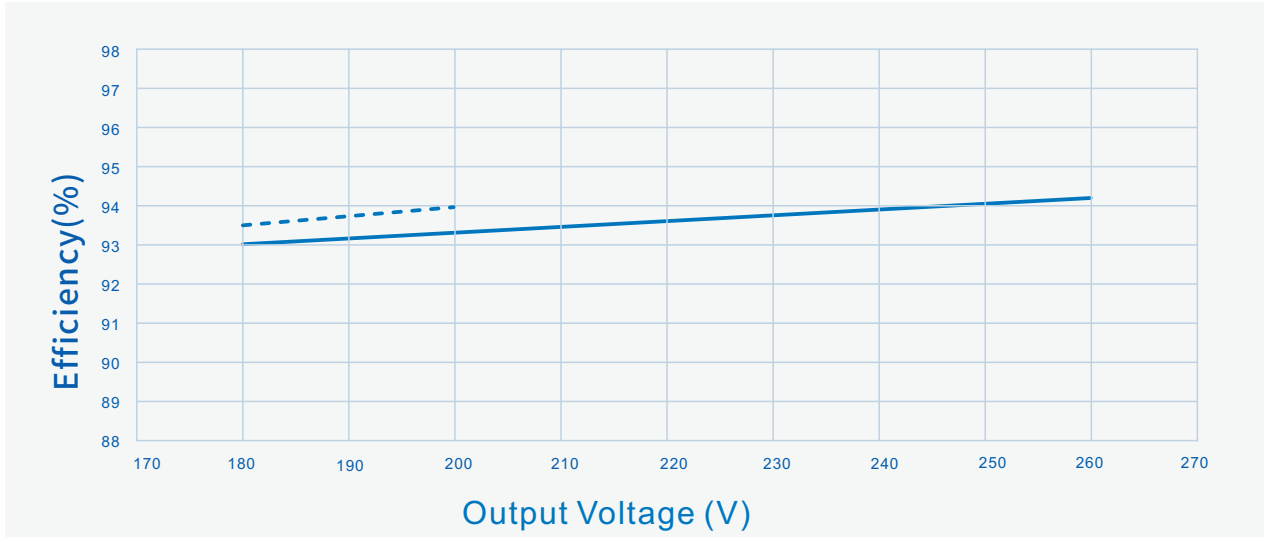

----- $I_o=800mA$

————— $I_o=620mA$

Efficiency Vs. Output Voltage ($V_{in}=347V_{ac}$)

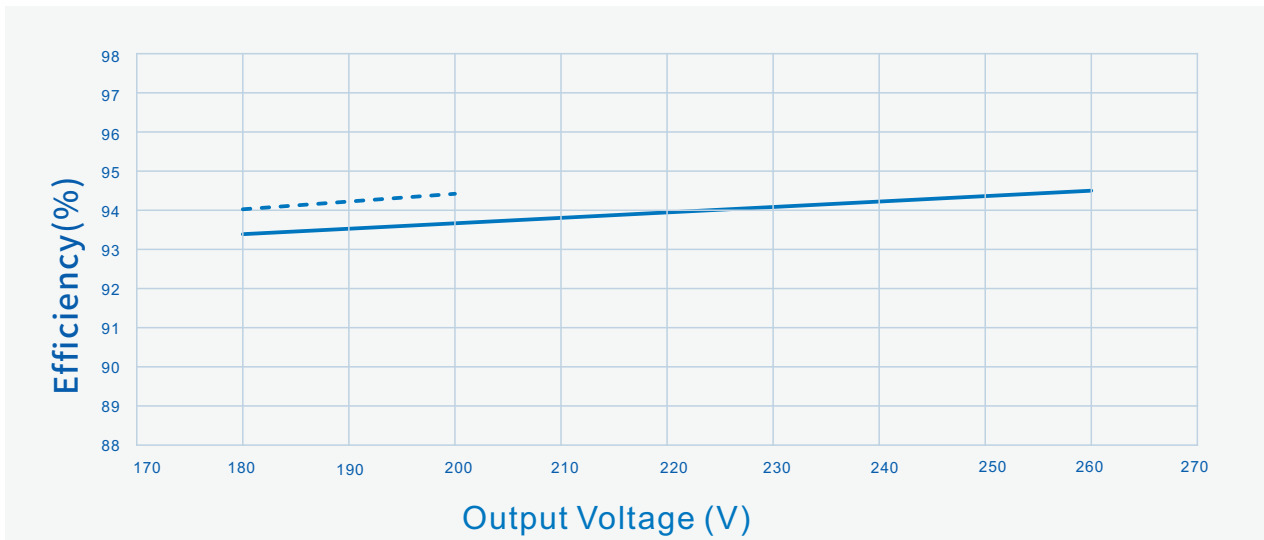

----- $I_o=800mA$

————— $I_o=620mA$

SS-160NM-A Series LED Driver

Performance Curves:

Power Factor Vs. Output Power

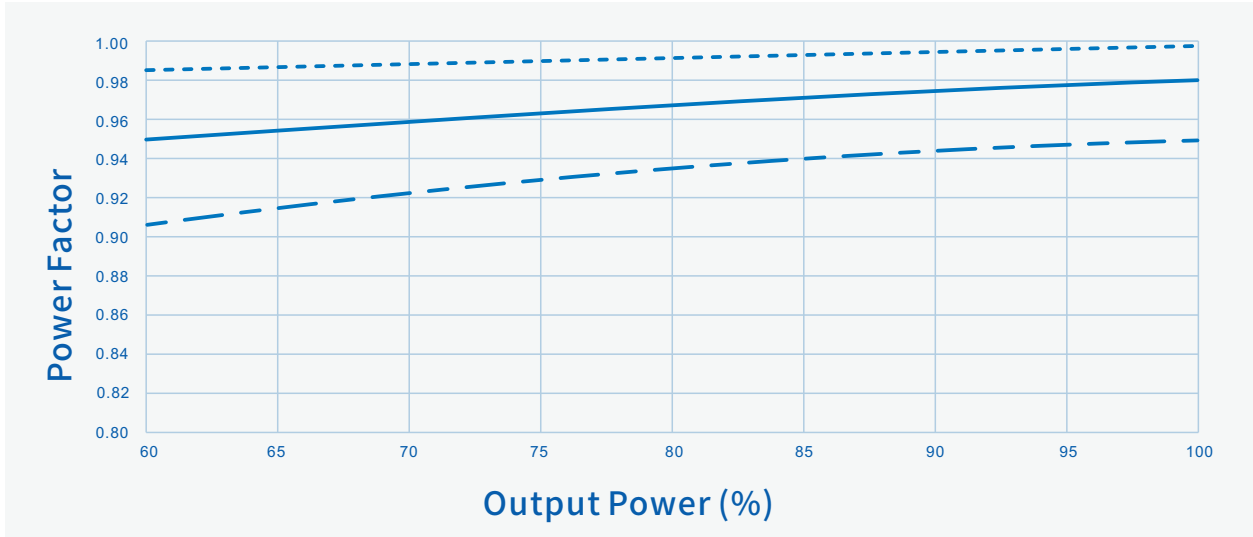

----- Vin=120Vac ——— Vin=220Vac - - - Vin=347Vac

THD Vs. Output Power

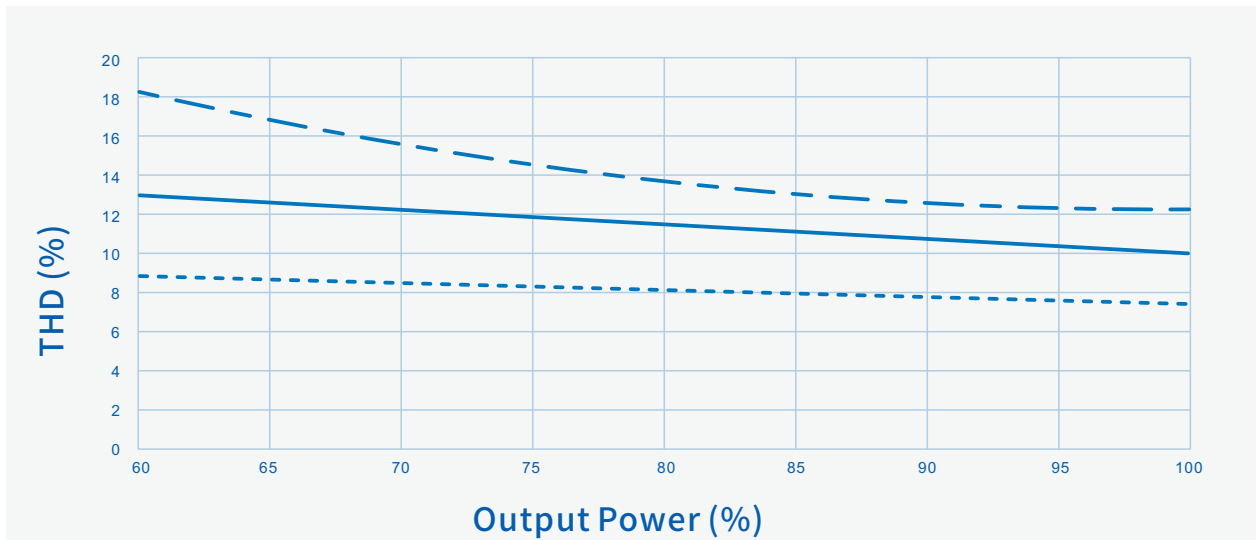

----- Vin=120Vac ——— Vin=220Vac - - - Vin=347Vac

SS-160NM-A Series LED Driver

Performance Curves:

Output Power Vs. Input Voltage

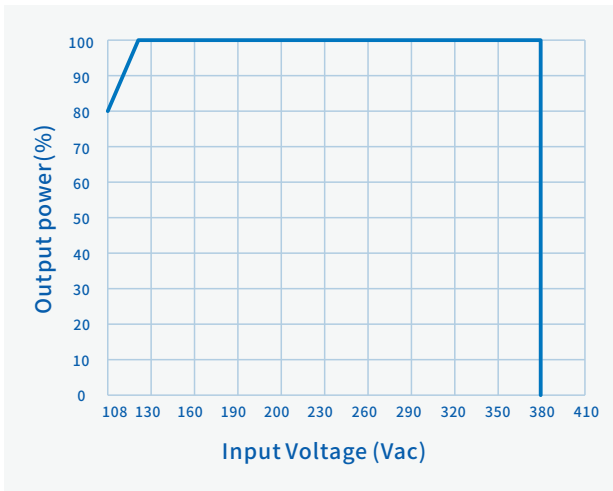

Output Power Vs. Case Temperature

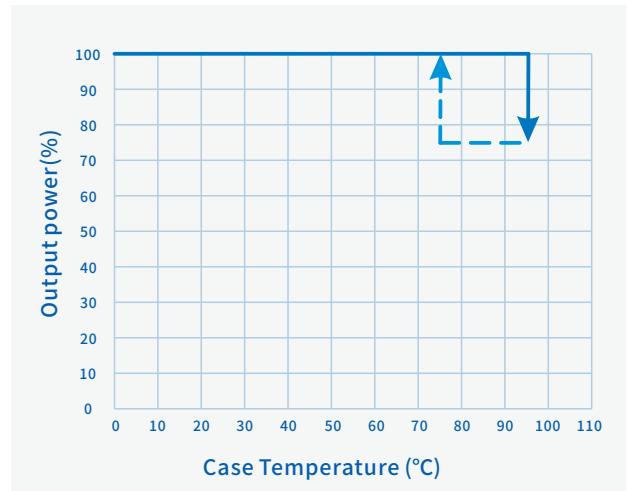

Output Power Vs. Dimming

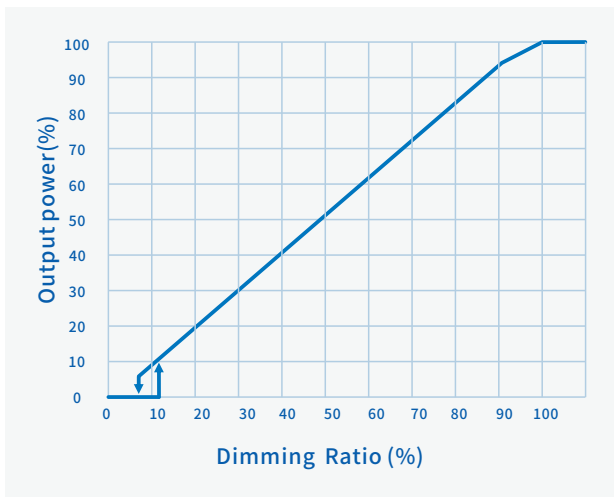

Lifetime Vs. Case Temperature

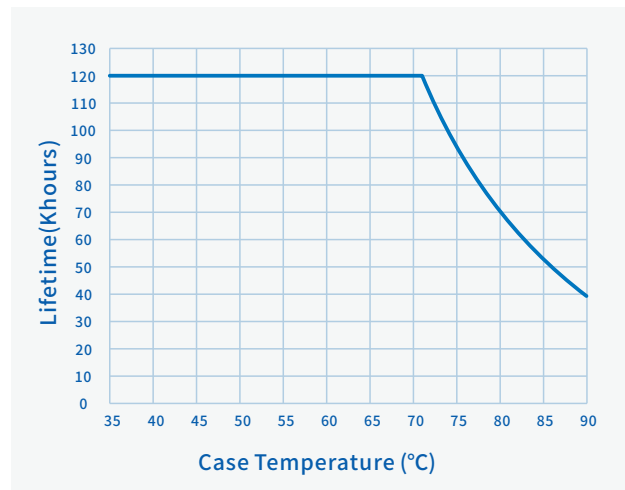

SS-160NM-A Series LED Driver

Mechanical Characteristics(B Model)

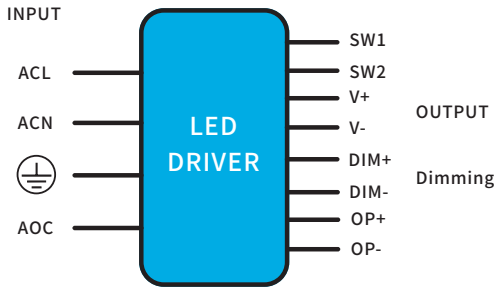

AC Input Cable(Exposed Length 300±10mm):

UL/EU model: 18AWG 105°C 600V O.D: 2.77mm,Black:ACL,White:ACN,Green:⊕

DC Output Cable(Exposed Length 300±10mm):

UL/EU model: 18AWG 105°C 300V O.D: 1.95mm,Red:V+, Black:V-

Resistance power regulating line with terminal Cable:

UL/EU model: 24AWG 150°C 300V O.D: 1.6mm,Orange: SW1,SW2

Optical control line with terminal:

UL/EU model: 24AWG 150°C 300V O.D: 1.6mm,Red: OP+,Black: OP-

DIM Cable(Exposed Length 220±10mm):

UL/EU model: 22AWG 105°C 300V O.D: 1.52mm, Purple: DIM+, Pink: DIM-

Name Description	Standard Code	mm(In.)
Case Length	L3	167(6.57)
Case Width	W2	52.5(2.07)
Case Height	H	34(1.34)
Overall Length	L1	185(7.28)
Mounting Hole Length	L2	175.5(6.91)
Mounting Hole Width	W1	32(1.26)
TC Point Position	X	32(1.26)
TC Point Position	Y	24(0.94)

Note:

- Please follow the "LED Driver User Manual" obtained from SOSEN's official website for assembly.
- AC Input Cable,DC O/P Cable,DIM Cable:
Tinned length of wire:10±2mm

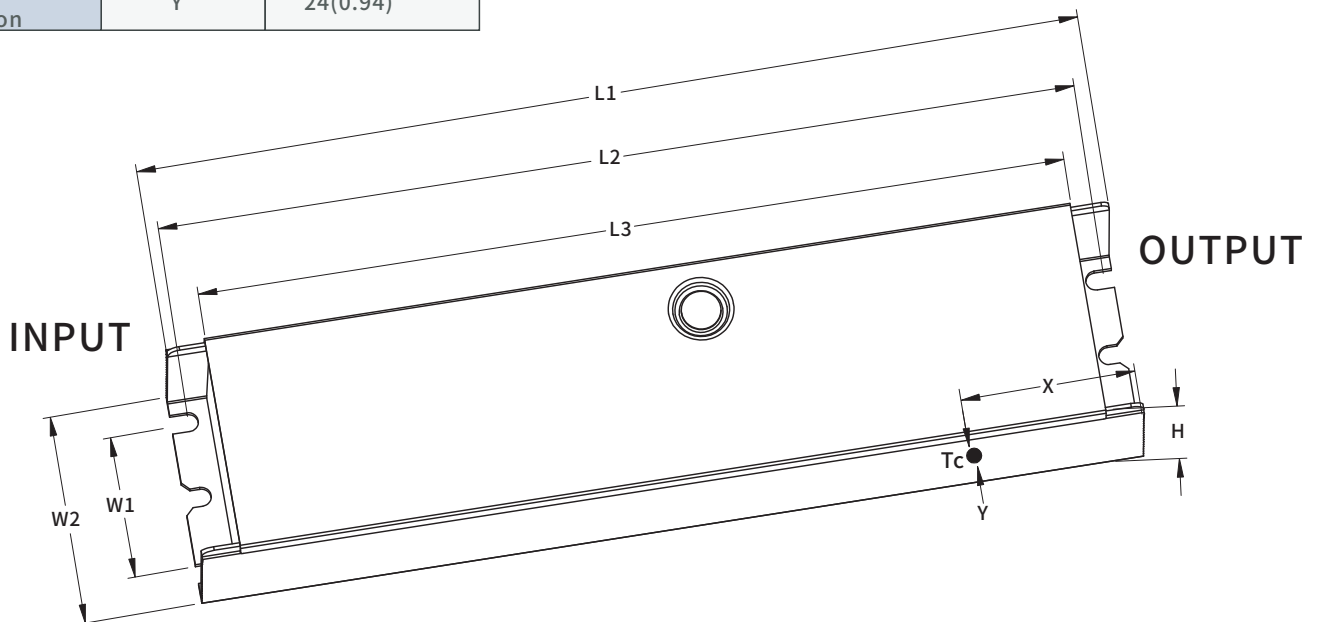

SS-160NM-A Series LED Driver

Mechanical Characteristics(BH Model)

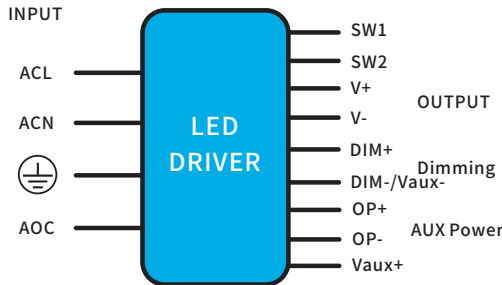

AC Input Cable(Exposed Length 300±10mm):

UL/EU model: 18AWG 105°C 600V O.D: 2.77mm,Black:ACL,White:ACN,Green:⊕

DC Output Cable(Exposed Length 300±10mm):

UL/EU model: 18AWG 105°C 300V O.D: 1.95mm,Red:V+, Black:V-

Resistance power regulating line with terminal Cable:

UL/EU model: 24AWG 150°C 300V O.D: 1.6mm,Orange: SW1,SW2

Optical control line with terminal:

UL/EU model: 24AWG 150°C 300V O.D: 1.6mm,Red: OP+,Black: OP-

DIM/AUX Power Cable(Exposed Length 220±10mm):

UL/EU model: 22AWG 105°C 300V O.D: 1.52mm, Purple: DIM+, Pink: DIM-/Vaux-, Black/White: Vaux+

Name Description	Standard Code	mm(In.)
Case Length	L3	174(6.85)
Case Width	W2	52.5(2.07)
Case Height	H	34(1.34)
Overall Length	L1	192(7.56)
Mounting Hole Length	L2	182.5(7.19)
Mounting Hole Width	W1	32(1.26)
TC Point Position	X	32(1.26)
TC Point Position	Y	24(0.94)

Note:

- Please follow the "LED Driver User Manual" obtained from SOSEN's official website for assembly.
- AC Input Cable,DC O/P Cable,DIM Cable:
Tinned length of wire:10±2mm

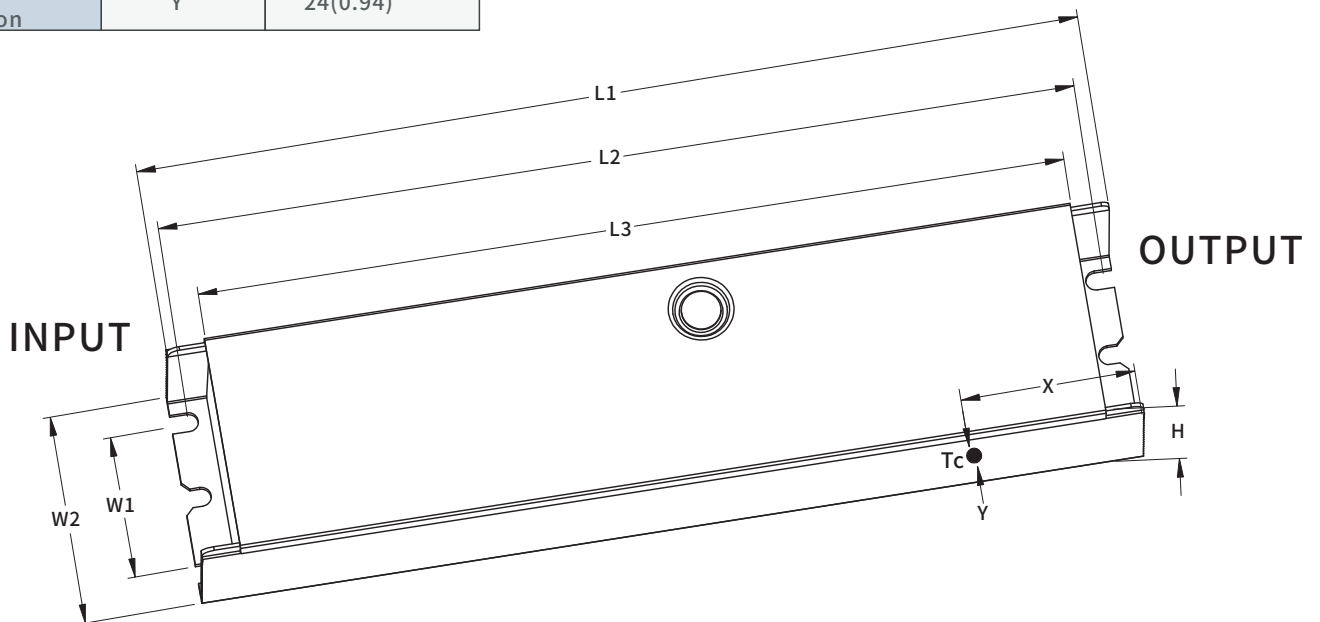

SS-160NM-A Series LED Driver



Assembly Tips

1. Highly recommended to seal the adjustable hole with silicon glue(#704 preferred) after adjusting the Driver's output current. Avoid permanent damage to adjust the potentiometer with suitable strength.
2. Dimming or AUX Power tinned connectors should be capped if not used to avoid dimming or AUX Power parts damage from external signals.
3. In order to meet the requirements of the power derating and the maximum ambient temperature of 50°C, an auxiliary heat sink must be added. It is recommended that the heat sink has a heat dissipation area of 380cm² and volume of 115cm³. Thermal grease should be applied between led driver and the auxiliary heat sink to ensure the bottom of housing is in close contact with the heat sink.
4. Safety space between aluminum base and LED coppers >5mm.
5. Safety space/coppers between LED+ and LED- >1.8mm.
6. Minimize the copper area on the aluminum PCB to reduce parasitic capacitance and leakage current.
7. It is recommended to design LED beads in parallel first and then in series.
8. The insulation level of LED light panels should meet the reliability design requirements.
9. For other precautions, please refer to the "LED Driver User Manual" .
10. SOSEN reserves the right of final interpretation of the above parameters.

Package

- Outside carton dimension: L×W×H=495mm×385mm×162mm;
- 16PCS/Carton;
- Net weight/Piece: 0.485kg;Gross weight/Carton: 9.79kg;
- Net weight/Piece: 0.535kg;Gross weight/Carton: 10.1kg;
- Please refer to the product name, model number, manufacturer identification, QC PASS, manufacturing date on the package.

Transportation

Packaging is designed suitable for transportation by trucks, vessels and flights. The products should be avoided direct sunlight and rain, loaded/unloaded with caution.

Storage

The product storage meets the standard of the GB 3873—83.
Products should be rechecked if stored for over 1 year before assembly.

RoHS

Products comply with RoHS Directive (2011/65/EU) and amendment 2015/863/EU.

Revision History

Version	Description of Update	Updated Date	Remark
V00	Original Release	2023/02/01	
V01	Update Mechanical Characteristics	2023/03/10	
V02	Update No Load Voltage	2023/03/31	
V03	Update Assembly Tips	2023/04/25	
V04	Delete SPD Input Cable	2023/05/06	
V05	Update Dim To Off	2023/05/24	
V06	Update Resistance	2023/09/11	